

PROPER ROOFING OF THE ROOF

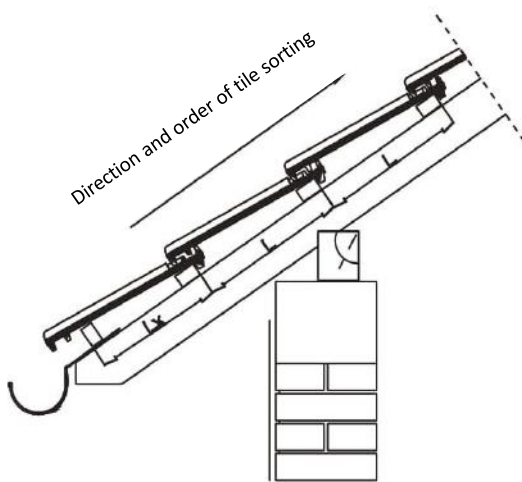

GLINEX TREND

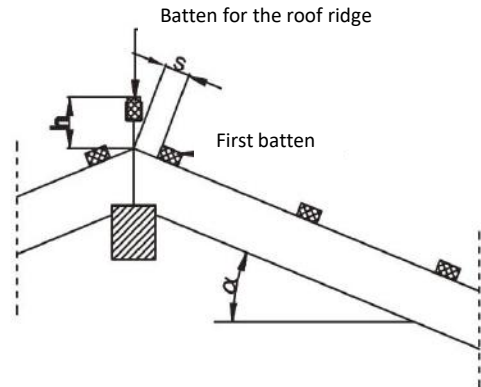

Recommended distance between battens (mm) L = 350
 Recommended distance of the first batten (mm) L = 310

Roof inclination „α“	20°	30°	40°
Position of the first batten “s”	60 mm	50 mm	40 mm
Position of the ridge batten “h”	110 mm	90 mm	85 mm

SYSTEM OF „DRY” MOUNTING OF THE ROOF RIDGES

Roof ridge

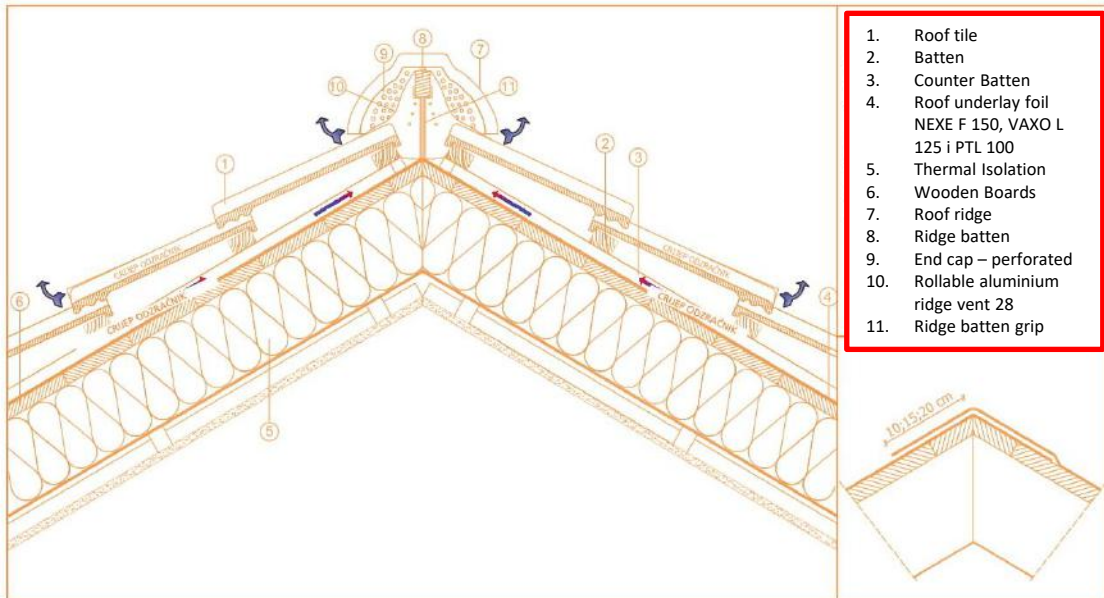

1. Roof tile
2. Batten
3. Counter Batten
4. Roof underlay foil NEXE F 150, VAXO L 125 i PTL 100
5. Thermal Isolation
6. Wooden Boards
7. Roof ridge
8. Ridge batten
9. End cap – perforated
10. Rollable aluminium ridge vent 28
11. Ridge batten grip

- **ridge batten grips (11)** are placed on the connection point of two rafters. They are installed on every rafter. First a leveling grip is installed, and then other ridge batten grips are positioned in a defined axis.
- **ridge batten** with 3x5cm dimensions is placed on top of the ridge batten grips. The ridge batten is fixed with screws. It is necessary to perform leveling.
- **Rollable aluminium ridge vent 28** is placed on top of the ridge batten. A self-adhesive tape is found on the rollable aluminium ridge vent which serves for sticking and gluing the rollable aluminium ridge vent to the roof tile and for adapting to the tile profile and pattern.
- Later, the ridge tile clamps are fixed and mounted and roof ridge tiles are positioned and mounted.
- End cap – perforated for roof ridge tiles is positioned and mounted after roof ridge tiles mounting and it is fixed with a nail to the roof ridge batten.

BLUEPRINT OF RIDGE WITH ferroconcrete (reinforced concrete) PLATE

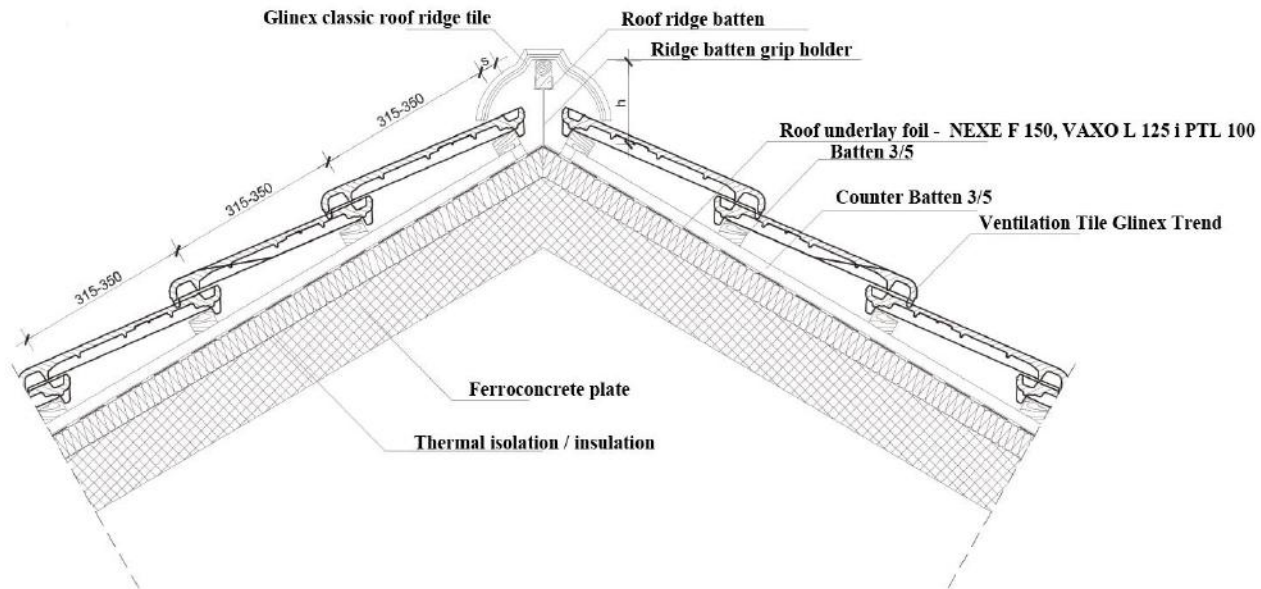

BLUEPRINT OF ROOF RAKE WITH ferroconcrete (reinforced concrete) PLATE

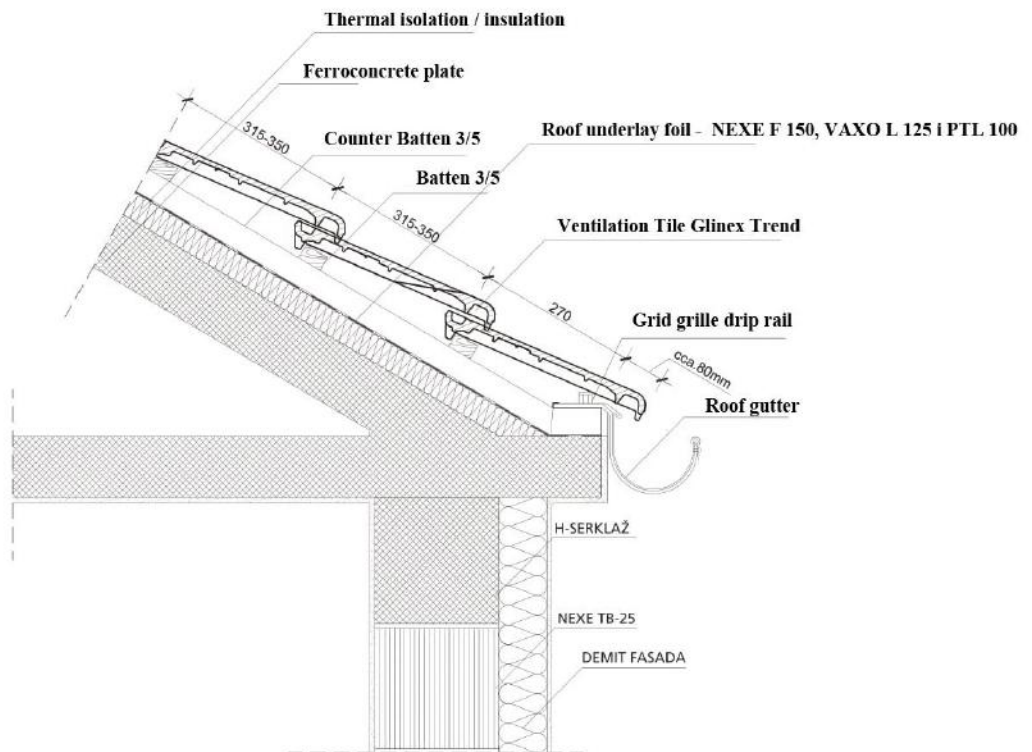

MOUNTING THE ROOF UNDERLAY FOIL

- Roof underlay foil is positioned and mounted horizontally from the bottom to the top.
- Boarding is not mandatory, therefore the roof underlay foil is mounted directly on the rafters which puts a great relief and enables financial savings.
- It is positioned and mounted on top of a roughly processed roof construction without the use of chemical protection for the wooden construction.
- The logo NEXE F 150, VAXO L 125, PTL 100 must be on the top surface, visible from the top surface.
- foil is stretched over the rafters, and mounted with counter battens (with nails) or with a roof stapler
- In roof underlay mounting overlap of the foils must be minimaly 10 cm and maximaly 20 cm (depending on the roof slope)

Roof rake

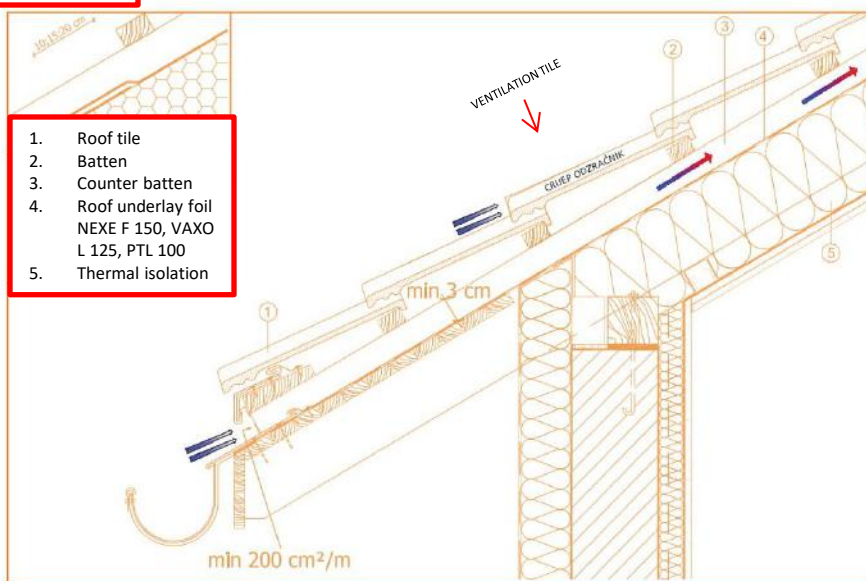

ROOF SLOPE	ROOF UNDERLAY OVERLAP
>30deg	10 cm
>20deg	15 cm
<20deg	20 cm

MINIMAL SLOPE
17deg

- Time frame of mounting is 3 months
- A air space Between the roof underly foil and the tile must be at least 3 cm
- Place of air entry into the construction (on the roof rake) is protected by using bird protection grille 10 which prevents bird entry and other pests.
- Proper air ventilation and air flow on the roof ridge can be achieved by using a „dry” technique and method of roof ridge tile installation or with mounting of the ventilation tiles in the second row from the roof ridge
- It is possible to walk over the foil only if the adequate surface is beneath it
- In the rood valleys under the sheet metal is mounted as aa double, and overlaps aree glued with a diffuse duct tape
- Diffuse duct tape is mandatory for gluing overlaps when the roof inclination is les than 20 deg.

ROOFING EQUIPMENT

ROLLABLE ALLUMINIUM RIDGE VENT 28

Universal element of roofing equipment designed for dry execution of ridge which ensures ventilation underneath the ridge tile. On the edge on both sides of the vent, there are self-adhesive tapes for attaching to the tile.



Brick

Burgundy

Brown

Black



- Tape width: 280 mm



- Tape length: 5 mm



- Free cross-section for ventilation: 145cm² / m per roof plane



- Consumption: ~ 1m VR 280 ALU / m' ridge



- Available colors: brick, burgundy, black, brown

RIDGE BATTEN GRIP

A metal element used to fasten the ridge batten. By using it and placing it correctly, you get an accurate and straight line of ridge tiles.



- Length 210 mm



- "U" profile size 20x50x55mm



- Consumption: ~ 1m piece / 0.8m ridge

BIRD PROTECTION GRILLE

Bird protection grille is used at the lower roof ventilation openings so as to prevent birds and insects from entering the roof structure.



Natural

Black

Brown



- Strip width: 100 mm



- Strip length: 5m



- Free cross-section for ventilation: 80%



- Consumption: ~ 1m perforated strip / m' drip



- Available colors: brick, black, brown

CLASP AGAINST STORMS

Zinc clasp against storms (storm resistant fastener) is used in areas with frequent and strong winds. It increases the safety of the construction and the resistance of tiles to wind gusts. It is placed sideways along the tile slot. The fastener is universal for all models of Nexe tiles.

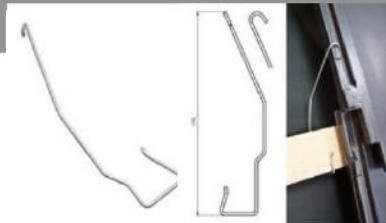

- Consumption: it is recommended to be placed on each tile along the roof perimeter (eaves, ridge, left and right roof edge). On the rest of the roof it is placed on every fourth tile.

RIDGE TILE CLAMPS

Painted metal fastener used to fasten ridge tiles in the dry installation process. A tile is screwed to the batten the, and then the other screw is used to connect the clamp directly to the batten.



Brick

Burgundy

Brown

Black



- Consumption: 1 piece / 1 ridge tile



- Available colors: brick, burgundy, black, brown

BEGGINIG / END CAP FOR RIDGE TILE - PERFORATED

The end cap is used to close the ridge ends while preserving ventilation. It prevents birds and insects from entering the roof structure.



Black

Burgundy

Brown

Black



• Free cross-section for ventilation: 16cm / pc

• Available colors: brick, burgundy, black, brown

METAL SNOW GUARD R

Their purpose is to prevent the occurrence of avalanche-like snow sliding with Glinex Trend and Klasik + tile models.



Brick

Burgundy

Brown

Black



• Material: Galvanized steel sheet



• Available colors: brick, burgundy, brown, black

METAL SNOW GUARD IDEAL

Their purpose is to prevent the occurrence of avalanche-like snow sliding with Ideal and Ideal + tile models.



Brick



• Material: Galvanized steel sheet



• Available colors: brick

ROOF UNDERLAY FOIL

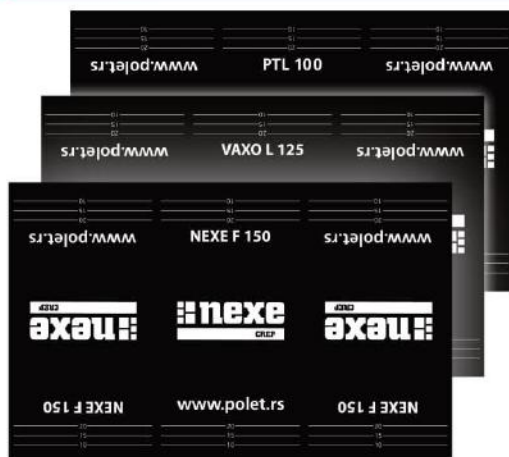

Highly vapor-permeable, watertight underlays NEXE F 150, VAXO L 125 and PTL 100.

Functions of vapor-permeable, watertight underlays NEXE F 150, VAXO L 125 and PTL 100:

- enable proper drying of the structure and insulation materials
- enable the creation of a pleasant microclimate in the space
- due to their properties, they increase the thermal insulation properties by about 10%
- extend the life of the structure, understructure and cover
- possibility of placing on the roof formwork, purlins or sloping concrete slab
- prevent the penetration of pests and thus protect the structure from decay and rot
- prevent cooling and condensation of water in the thermal insulation

BASIC CHARACTERISTICS of the roof underlay foils:

NEXE F 150
VAXO L 125
PTL 100

CHARACTERISTICS	Measuring Unit	PTL 100	VAXO L 125	NEXE F 150
Length	m	50	50	50
Width	m	1,5	1,5	1,5
Area	m ²	75	75	75
Weight	g/m ²	100 (±15%)	125 (±15%)	150 (±7%)
Tear strength	N/50mm	220/130 (±20%)	240/120 (±30%)	290/235 (±20%)
Water penetration resistance	class	W1	W1	W1
Reaction to fire	class	F	F	F
Low-temperature flexibility	°C	-40	-40	-40
Vapor permeability	Sd	0,02 m (±15%)	0,03 m (±15%)	0,02 m (±15%)
UV resistance	month	2	3	3

Consumption: ~ 1.1 m² of underlay / m² of roof surface

Additional technical specifications:

Description of „dry“ mounting technique.

In the case of using a „dry“ technique for roof ridge mounting the following products are included which assure the longevity and proper function of the roof and roof ridge tiles. The included products are as follows:

- Roof underlay foil,
 - Rollable aluminum ridge vent,
 - Ridge batten grip,
 - Ridge and hip battens
 - Ridge tile clamps,
 - Clasp against storms
 - End cap – perforated
 - Bird protection grille
 - Diffuse duct tape
- is recommended

In addition, when using the „dry“ mounting technique for the roof ridge tiles the bottom longitudinal portion of the roof ridge tile must be in direct contact with the ridge batten. Other technical specifications must be adhered to, such as the distance between the top of the ridge (top most point of contact between two rafters) and the first batten, the height of the ridge batten and the proper inclination of the roof rafters.

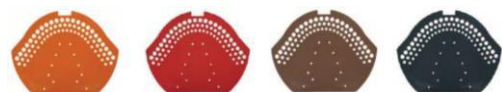

Product application VIDEO

nexe
ROOF TILE



WARRANTY



for roof tile

purchased on

(name, location, and company stamp)

for installation on the building

(address)

account number

customer

(Name and Surname)

40 YEAR WARRANTY

1. AD Polet IGK Novi Becej guarantees that the supplied roof tiles in the above mentioned period (40 years) will fulfill the quality criteria defined by the national standards SRPS EN 1304 I SRPS EN 1024, SRPS EN 538, SRPS EN 539-1, SRPS EN 539-2.

2. If the roof tile within the warranty period does not meet any of the criteria defined by the abovementioned standards substantially affecting its functionality, AD Polet IGK Novi Becej shall be obliged to replace all roof tiles in which deficiencies are found, related to the characteristics of the tiles from the warranty coverage.

3. Deficiencies relating to the following are excluded from the warranty:

- mechanical damages caused by force majeure (eg natural disasters)
- temporary changes in roof tile aesthetics that do not impair its functionality, whether caused by transportation, handling, or are the result of adverse weather conditions in the environment.
- inappropriate use of roof tiles

4. Customer undertakes to carry out the installation of roof tiles in accordance with the Regulations on technical standards for design and execution of finishing construction works, as well as in accordance with the manufacturer's instructions relating to the application of the product, which are contained in the manufacturer's data sheet prevailing at the time of making the roof.

5. Warranty period of 40 years shall apply only if the conditions under Items 2 and 4 are met.

6. The warranty period starts from the month and year of manufacture of roof tiles (month and year of manufacture are indicated by a permanent mark on the back of roof tile).

7. When making a complaint regarding the quality of roof tile, the customer shall:

- send the complaint to the manufacturer in a written form
- specify the type of roof tile, quantity, place of installation, reasons for complaint, date of purchase and type of damage.
- submit a bill for the goods purchased and a warranty card along with the complaint!

8. Warranty shall be valid for the following types of roof tiles: IDEAL, IDEAL +, GLINEX TREND, KLASIK + (natural and engobed).



AD POLET
Construction ceramics industry
Železnička 13,
23272 Novi Becej
The Republic of Serbia

Phone: +381 (0) 23 771 971
+381 (0) 23 771 970
Fax: +381 (0) 23 773 300
E-mail: polet@nexe.rs